

ACOUSTIC4YOU

INFO@TRADING-24.PL

CORKBEE is a polish brand that combines passion for good design and simple forms. We focus on high quality and sincerity of material. Our goal is to create unique products that will complete any interior and context. Idea of natural design, based on simplicity and using goods of nature, guided us to create Corkwall collection.

CORKBEE to polska marka łącząca w sobie zamiłowanie do unikalnego designu i prostych form. Stawiamy na wysoką jakość i szczerść materiału. Naszym celem jest tworzenie rzeczy wyjątkowych, które sprawdzą się w każdym wnętrzu i kontekście. Idea naturalnego designu, opartego na prostocie i korzystaniu z dóbr natury, zainspirowała nas do stworzenia kolekcji Corkwall.

What is a Corkwall?

Corkwall is a collection of an environment friendly 3D wall panels made of cork granulates. It is a combination of unique design and care for the environment. A combination of high quality with the sincerity of the material. Naturally.

Corkwall is a unique 3D wall decoration that completes any interior. It takes care of its acoustics and microclimate. It is created without harm to the environment. Thanks to their shape, corkwall panels can be arranged in one direction, create symmetrical patterns or create a unique composition. There are countless combinations.

Co to Corkwall?

Corkwall to kolekcja przyjaznych dla środowiska paneli ściennych 3D wykonanych z naturalnego granulatu korkowego. Jest to połączenie unikalnego designu z dbałością o środowisko. Połączenie wysokiej jakości ze szczerścią materiału. Naturalnie.

Corkwall to niepowtarzalne panele ścienne 3D, które nie tylko stanowią wyjątkowy dodatek, ale też w zupełnie nowy sposób dodadzą Twojemu wnętrzu przytulności i wyjątkowości. Zadbają o jego akustykę i mikroklimat. Powstaną bez szkód dla środowiska, które jest naszym priorytetem i będą biodegradowalne. A przy tym wszystkim dadzą Ci również niezliczone możliwości w kreowaniu wyglądu wnętrza, zapewniając oryginalność.

The inspiration

Our inspiration is Nature, which is characterized by uniqueness, durability and timelessness. This is why, we create environment friendly products. Our panels are made of renewable, recyclable and biodegradable material. Cork.

We combine modern, sophisticated design with care for the environment.

Inspiracja

Naszą inspiracją jest natura, którą cechuje niepowtarzalność, trwałość i ponadczasowość. Dlatego właśnie tworzymy produkty przyjazne środowisku. Nasze panele powstają z materiału odnawialnego, nadającego się do recyklingu i biodegradowalnego. Korka.

What is Corkwall made of?

Obviously, to make Corkwall panels we use cork. However, we do not extract it specifically for our needs but we use a by-product from the production of wine corks. Granulated cork is molded in shape with mass color pigmentation.

Z czego wykonane są panele Corkwall?

Do produkcji naszych unikalnych paneli używamy korka. Nie wytwarzamy go jednak specjalnie na nasze potrzeby. Nie wycinamy go też z bloków korkowych. Używamy produktu ubocznego powstałego przy produkcji korków do win.

Produkt końcowy formujemy przy użyciu ciśnienia i temperatury w formach do tego stworzonych.



NATURAL

POSSIBILITIES OF INSTALLATION (EXAMPLES)
 PRZYKŁADOWE MOŻLIWOŚCI MONTAŻU

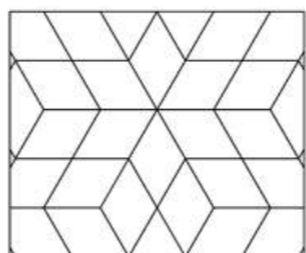
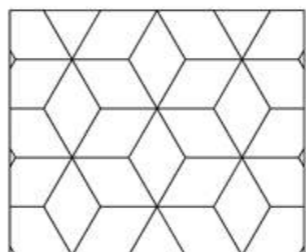
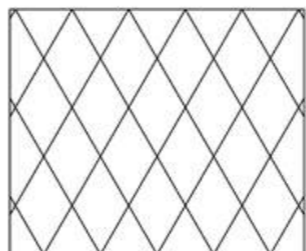
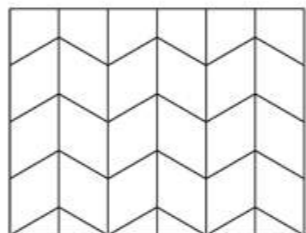

STRIPE

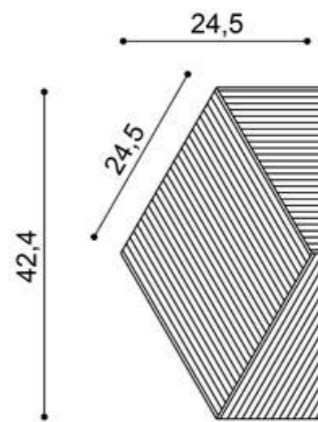

CORKWALL PANELS: Agglomerated cork produced using compression moulding technology
PANELE CORKWALL: Korek aglomerowany formowany pod ciśnieniem
PACKING: 12 pieces
PAKOWANIE: 12 sztuki
PANELS IN 1 M2: 19
LICZBA PANELI W 1 M2: 19
WEIGHT: 230 g Natural/ 250 g Colour
WAGA: 230 g Natural/ 250 g Kolor
THICKNESS: 5 mm - 12 mm
GRUBOŚĆ: 5 mm - 12 mm

COLOURS
 KOLORY





NATURAL

POSSIBILITIES OF INSTALLATION (EXAMPLES)
 PRZYKŁADOWE MOŻLIWOŚCI MONTAŻU

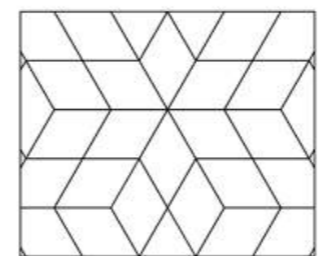
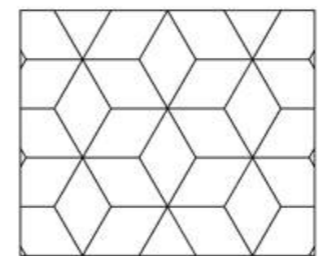
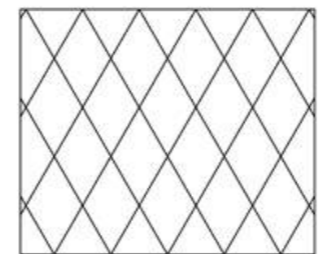
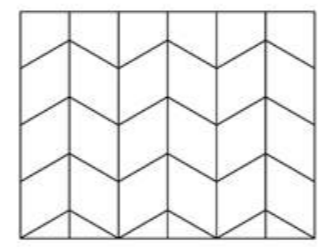

LINE

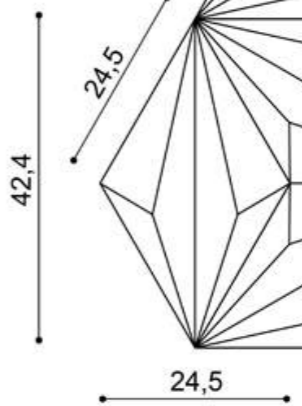

CORKWALL PANELS: Agglomerated cork produced using compression moulding technology
PANELE CORKWALL: Korek aglomerowany formowany pod ciśnieniem
PACKING: 3 pieces
PAKOWANIE: 3 sztuki
PANELS IN 1 M2: 19
LICZBA PANELI W 1 M2: 19
WEIGHT: 230 g Natural/ 250 g Colour
WAGA: 230 g Natural/ 250 g Kolor
THICKNESS: 5 mm - 30 mm
GRUBOŚĆ: 5 mm - 30 mm

COLOURS
 KOLORY





DARK GREEN

POSSIBILITIES OF INSTALLATION (EXAMPLES)
 PRZYKŁADOWE MOŻLIWOŚCI MONTAŻU

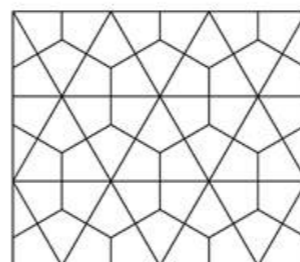
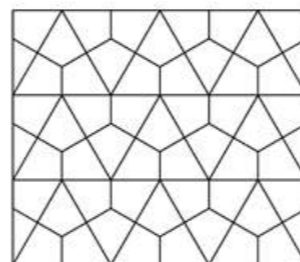
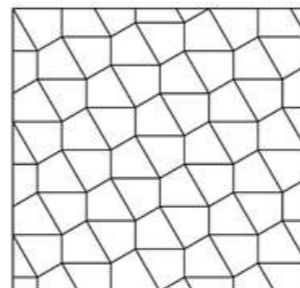
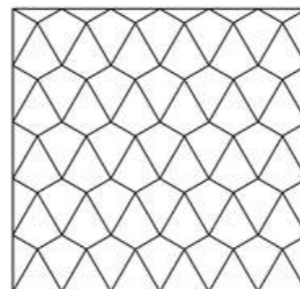

CORKWALL PANELS: Agglomerated cork produced using compression moulding technology

PANELE CORKWALL: Korek aglomerowany formowany pod ciśnieniem

PACKING: 6 pieces
PAKOWANIE: 6 sztuki

PANELS IN 1 M2: 40
LICZBA PANELI W 1 M2: 40

WEIGHT:
 150 g Natural/ 180 g Color
WAGA: 150 g Natural/ 180 g Kolor

THICKNESS:
 20 mm - 30 mm
GRUBOŚĆ: 20 mm - 30 mm

KITE



COLOURS
 KOLORY





GREY

POSSIBILITIES OF INSTALLATION (EXAMPLES)
 PRZYKŁADOWE MOŻLIWOŚCI MONTAŻU

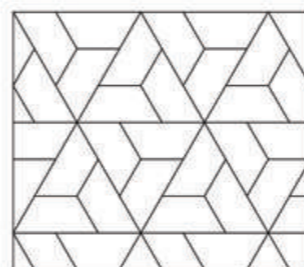
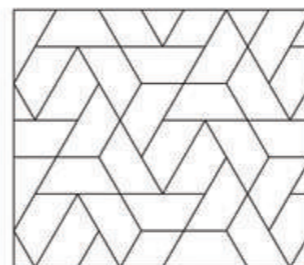
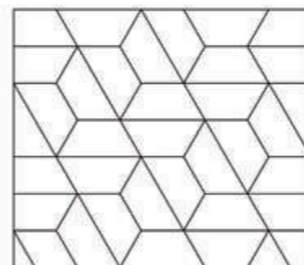
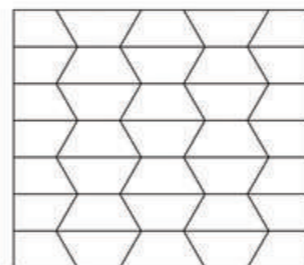

WEAVE

CORKWALL PANELS: Agglomerated cork produced using compression moulding technology

PANELE CORKWALL: Korek aglomerowany formowany pod ciśnieniem

PACKING: 9 pieces

PAKOWANIE: 9 sztuki

PANELS IN 1 M2: 25

LICZBA PANELI W 1 M2: 25

WEIGHT: 150 g Natural/ 180 g Colour

WAGA: 150 g Natural/ 180 g Kolor

THICKNESS: 5 mm - 15 mm

GRUBOŚĆ: 5 mm - 15 mm

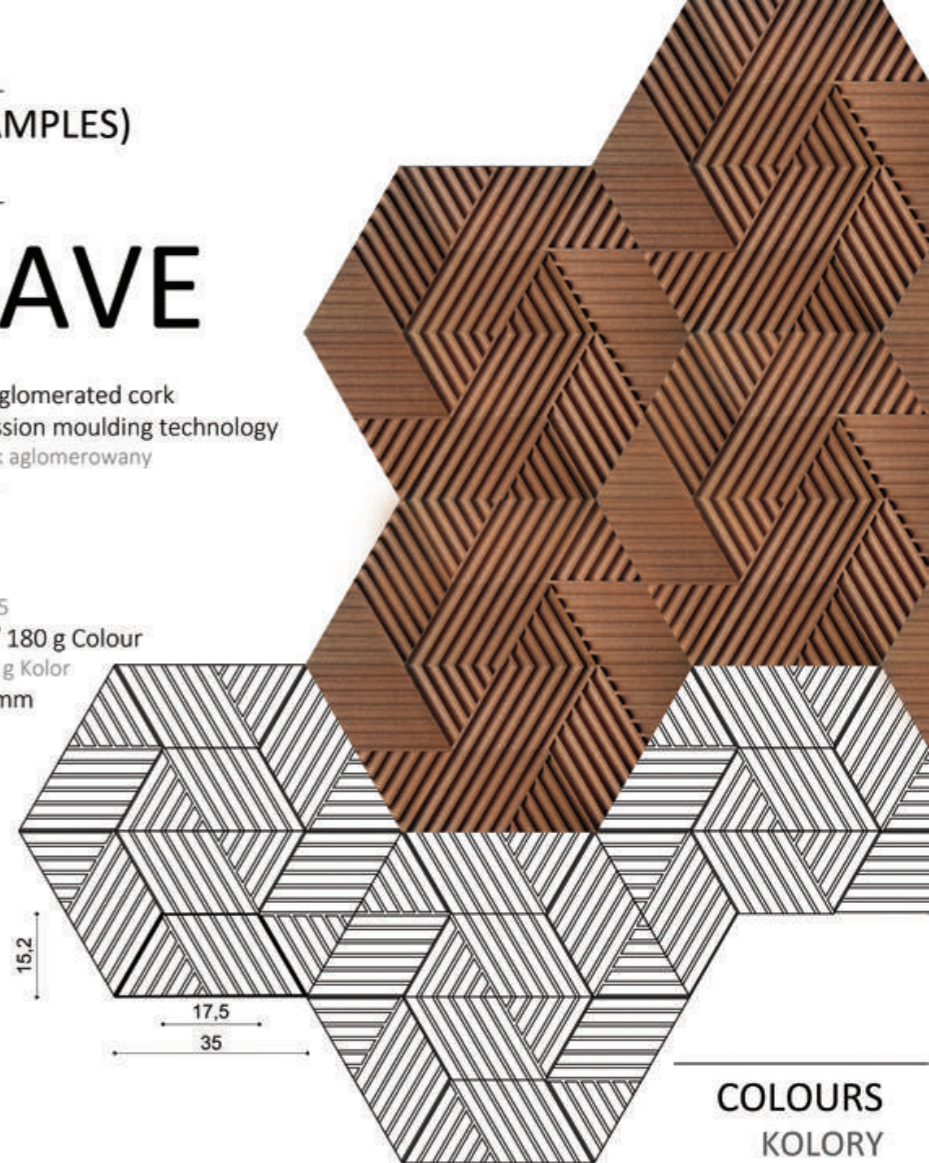

COLOURS
 KOLORY



IVORY



NATURAL



BROWN



YELLOW



GREY



MAROON



BLUE



DEEP BLUE



DARK GREN



GREEN



BLACK

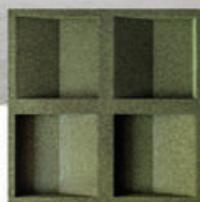

GREEN

POSSIBILITIES OF INSTALLATION (EXAMPLES)
 PRZYKŁADOWE MOŻLIWOŚCI MONTAŻU

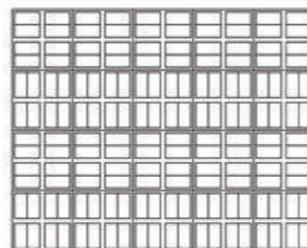
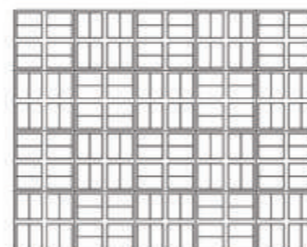
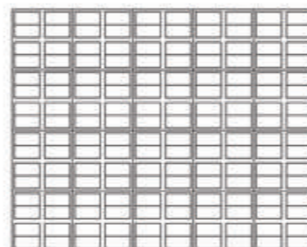

CONCAVE

CORKWALL PANELS: Agglomerated cork produced using compression moulding technology

PANELE CORKWALL: Korek aglomerowany formowany pod ciśnieniem

PACKING: 4 pieces

PAKOWANIE: 4 sztuki

PANELS IN 1 M2: 16

LICZBA PANELI W 1 M2: 16

WEIGHT: 300 g Natural/ 340 g Colour

WAGA: 300 g Natural/ 340 g Kolor

THICKNESS: 25 mm

GRUBOŚĆ: 25 mm

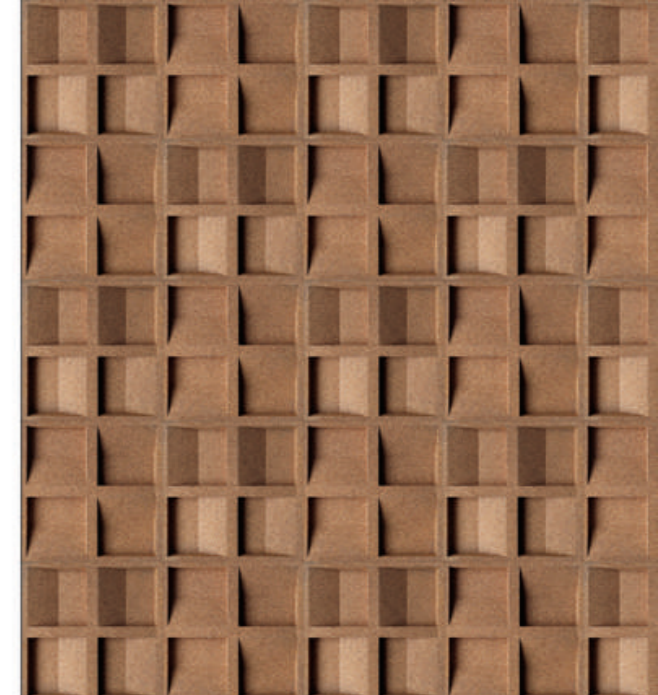

25

25

COLOURS
 KOLORY



IVORY



NATURAL



BROWN



YELLOW



GREY

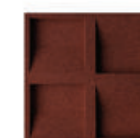

MAROON



BLUE

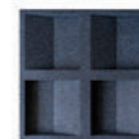

DEEP BLUE



DARK GREN



GREEN



BLACK

WHY CORKWALL

DLACZEGO CORKWALL



Environmentally friendly
Przyjazne środowisku



Renewable, recyclable and biodegradable
Odnawialne, nadające się do recyklingu,
biodegradowalne



Natural thermal and acoustic isolation
Naturalna izolacja termiczna i akustyczna



Antistatic
Antystatyczne



Lightweight
Lekkie



Easy to assemble
Łatwy montaż



Many possibilities of installation
Wiele możliwości ułożenia



11 colors available
11 dostępnych kolorów